

GRAPHIC SCALE
Scale: 1/4" = 1'-0"

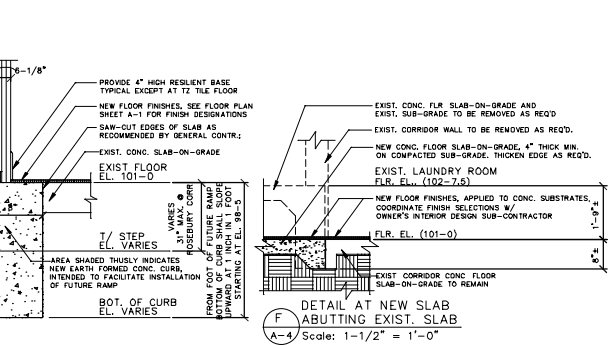
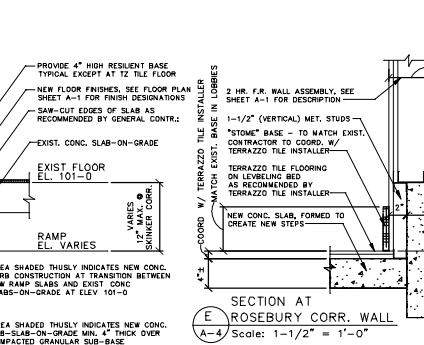
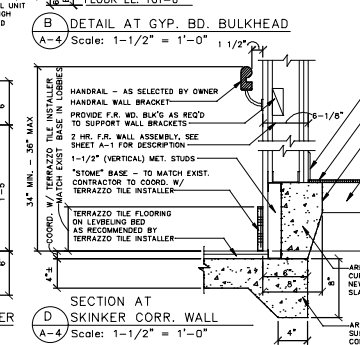
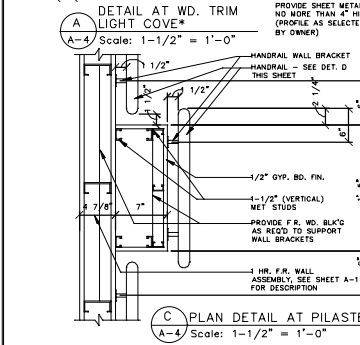
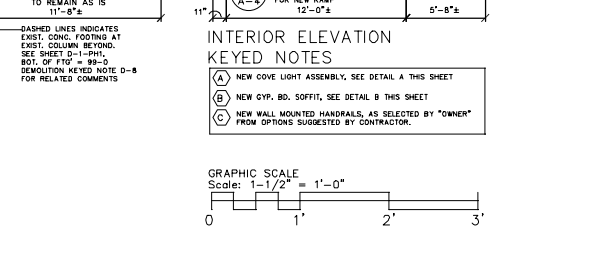
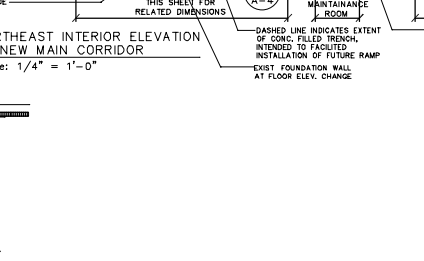
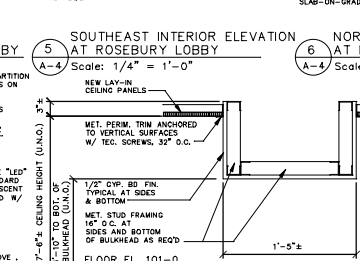
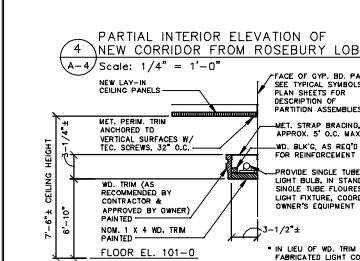
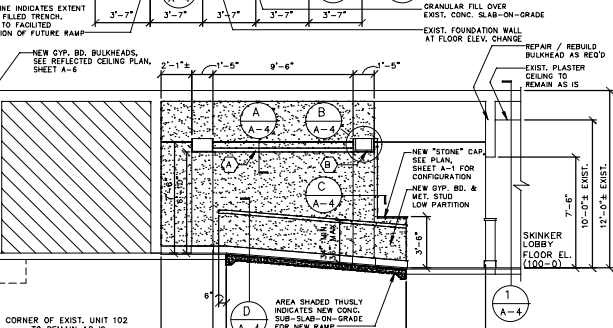
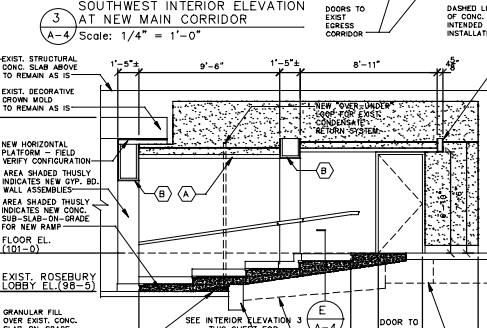
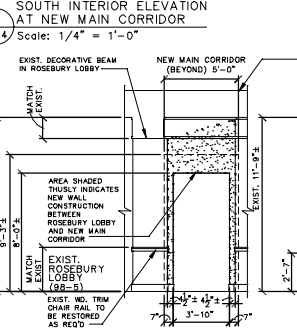
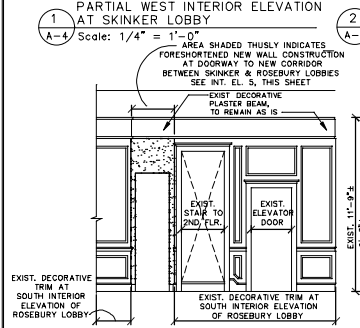
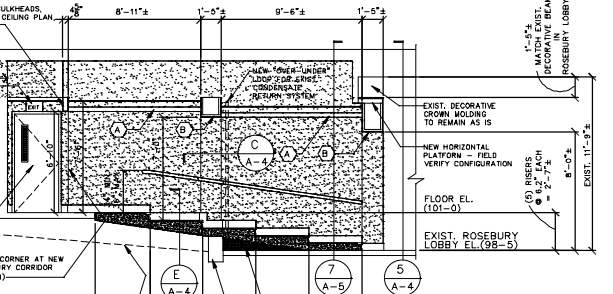
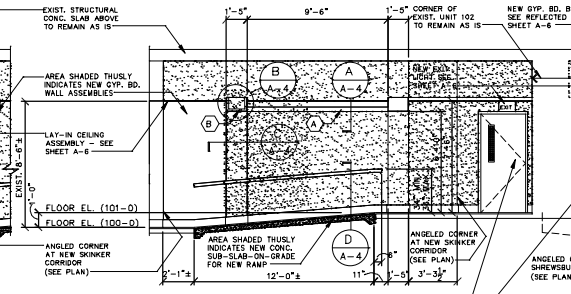
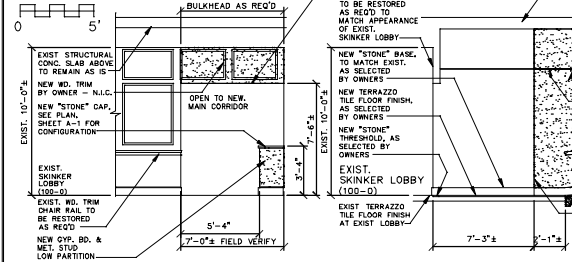

GRAPHIC SCALE
Scale: 1-1/2" = 1'-0"

ARCHITECT
ROBERT BRAUCH
REGISTERED ARCHITECT
STATE OF MISSOURI
LICENSE NO. 4-00488

ARCHITECT
ROBERT BRAUCH
4960 NEESH
ST. LOUIS, MO 63109

CORRIDOR MODIFICATIONS
VERSAILLES CONDO
701 SKINKER AVE.
ST. LOUIS, MO 63112

Date Issued: 01/31/14
Addendum:
#1 02/28/14
#2 03/03/14
#3 05/31/14
SHEET NO. A-4
Page 9 of 13